



Publisher homepage: [www.universepg.com](http://www.universepg.com), ISSN: 2707-4625 (Online) & 2707-4617 (Print)

<https://doi.org/10.34104/ijmms.023.019024>

**International Journal of Material and Mathematical Sciences**

Journal homepage: [www.universepg.com/journal/ijmms](http://www.universepg.com/journal/ijmms)

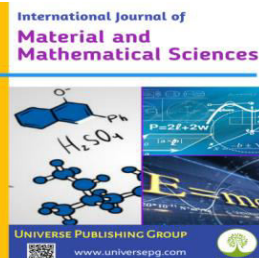

## Modification of Power Transmission System of BRRI Hydro-tiller

Mohammad Afzal Hossain<sup>1\*</sup>, Md Golam Kibria Bhuiyan<sup>1</sup>, Hafijur Rahaman<sup>1</sup>, Md Moudud Ahmmed<sup>1</sup>, Arafat Ullah Khan<sup>1</sup>, and Md Durrul Huda<sup>1</sup>

<sup>1</sup>Farm Mechanization and Postharvest Technology Program Area, Bangladesh Rice Research Institute (BRRI), Gazipur 1701, Bangladesh.

\*Correspondence: [enr.afzal@yahoo.com](mailto:enr.afzal@yahoo.com) (Dr. Mohammad Afzal Hossain, Senior Scientific Officer, Farm Mechanization and Postharvest Technology Program Area, Bangladesh Rice Research Institute (BRRI), Gazipur 1701, Bangladesh).

### ABSTRACT

The existing BRRI Hydro-tiller was tested at BRRI West byde to find out the causes of frequent tearing of hydro-tiller chain. Its capacity was found 0.023 ha/hr. The reason associated with the fault of hydro-tiller chain tearing was identified i.e. thickness of the chain was not sufficient to bear the load, strength of the bearing of the rotary box was not sufficient to bear the load. To overcome the problem, thickness of the sprocket was increased to 11 mm. ASME #60 chain was used instead of ASME #50 chain. Width of the ASME #60 chain is 23 mm. In addition, two bearings were set in combination with the rotary box shaft instead of a single bearing to increase the strength of the Hydro-tiller in smooth operation at full load condition. Size of each bearing was 62 mm x 16 mm. The complete design of the modified hydro-tiller was done with the help of Solid works tool. After that, the modified hydro-tiller was tested at BRRI west byde, Gazipur. After modification, the capacity of the hydro-tiller was increased to 0.039 ha/hr. Average fuel consumption of the modified hydro-tiller was 2.01 l/hr. The number of chain and belt tearing of the hydro-tiller has decreased drastically to below 8 per year after the modification. No event of engine stopping due to overloading arose during land cultivation.

**Keywords:** Modification, BRRI Hydro-tiller, Power transmission system, ASME #60 chain, and Modification.

### INTRODUCTION:

In rice cultivation, land preparation is one of the most labor-intensive and high-cost operations. The success of farming operations, especially tillage operations, depends greatly on the type of implements and farm machines used (e.g. tractors). Wanjun, (1983) found that farm machines to appeal to farmers, they must be suited to specific conditions, easy to operate and maintain, reliable, durable, and inexpensive. Specific local conditions that may also affect the machines' features include natural conditions, farming systems, scales of production, and economic and technical contexts. The Hydro-tiller is an Indonesian machine type that re-

sembles the floating tiller or the turtle tiller of the Philippines (Villaruz 1985; Tadeo *et al.*, 1993) and is appropriate for use in the water-logged areas. Al-Suhaibani *et al.* (2006) explained that the proper selection and matching of farm machines is essential for reducing farms' costs of ownership and operation. Accordingly, selecting the best size and type of the equipment for each application and matching machinery components in a complete system are important in the efficient management of machines (Kepner *et al.*, 2005) and in determining the profitability of a given farming system (Dash and Sirohi, 2008). The machine is commonly used for land preparation in developing

countries in wet land conditions, because they are particularly well-suited to small fields (Ujang, 2015; Tewari *et al.*, 2004; Uddin *et al.*, 2021).

Hydro-tiller, a walking type implement is widely used for rotary cultivation in wet puddle soil. It is an ideal where the land side is marshy where power tiller, tractor can not be driven. It is the best choice of the farmers with small and marshy plots. Hydro-tiller is successful to till water-flooded fields. Hydro-tiller works smoothening and loosening the soil and making it simpler to rice transplanting in water submerged field. In existing Hydro-tiller, chain tearing occurred frequently. Therefore, the study has been undertaken to get better maneuverability fulfilling the following objectives -

- 1) To detect the causes of frequent tearing of hydro-tiller chain
- 2) To modify the power transmission system for increasing longevity of hydro-tiller

#### **MATERIALS AND METHODS:**

Hydro-tiller was tested at BRRRI West byde to find out the causes of frequent tearing of hydro-tiller chain. The reason associated with the fault of hydro-tiller chain tearing was identified and necessary modification was done using M/S sheet, different types of gear, sprocket, bearing, chain etc. The complete design of the modified hydro-tiller was done with the help of Solid works tool. After that, the modified hydro-tiller was tested at BRRRI west byde, Gazipur.

#### **Theoretical field capacity**

Theoretical field capacity is the rate of field coverage of an implement that would be obtained if the machine were performing its function 100% of the time at the rated forward speed and always covered 100% of its width.

$$TFC = W \times S$$

Where,

TFC=Theoretical field capacity ( $m^2 hr^{-1}$ )

W=Operating width of the machine (m)

S= Speed ( $mhr^{-1}$ )

#### **Actual field capacity**

Actual field capacity is the ratio of actual rate of field coverage by the machine to the total time during operation.

$$AFC = \frac{A}{T}$$

Where,

AFC= Actual field capacity ( $m^2 hr^{-1}$ )

A= Area ( $m^2$ )

T= Operating time (hr)

#### **Field efficiency**

It is the ratio of effective field capacity to the theoretical field capacity of a machine under field conditions and the theoretical maximum productivity and it can be calculated by the following equation:

$$\eta = \frac{C}{C_o} \times 100$$

Where,

$\eta$  = Field efficiency (%)

C = Actual field capacity ( $m^2 hr^{-1}$ )

$C_o$  = Theoretical field capacity ( $m^2 hr^{-1}$ )

#### **Fuel consumption**

Before starting the operation in the test plot, the fuel tank of the engine was filled up to its top. The quantity of fuel required to fill the tank fully after puddling the plot was measured to determine the quantity of fuel consumed for puddling the test plot.

#### **RESULTS AND DISCUSSION:**

##### **Shortcomings and faults of the hydro-tiller**

Failure of the transmission chain occurred repeatedly. Stopping of engine arose occasionally due to overloading. The reason associated with the fault of hydro-tiller chain tearing was identified as the followings:

- 1) Thickness of the chain is not sufficient to bear the load.
- 2) Strength of the bearing of the rotary box is not sufficient to bear the load.

To overcome the problem, the following modification was done.

##### **Modification of the power transmission system of the hydro-tiller**

To increase of the strength of the power transmission elements of the Hydro-tiller, thickness of the sprocket and width of the chain was increased.

- 1) Thickness of the sprocket (9 mm) was increased to 11 mm (**Fig. 1**).

- 2) ASME #60 chain was used instead of ASME #50 chain. Width of the ASME #60 chain is 23 mm (Fig. 2).
- 3) Two bearing was set in combine to the rotary box shaft instead of single bearing to increase the

strength of the Hydro-tiller in smooth operation at full load condition. Size of each bearing was 62 mm x 16 mm (Fig. 3 & 4).

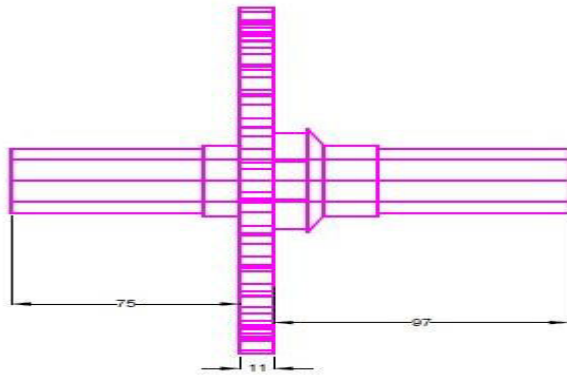

Fig. 1: Sprocket.

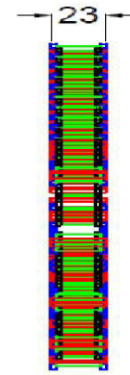

Fig. 2: Chain ASTM #60.

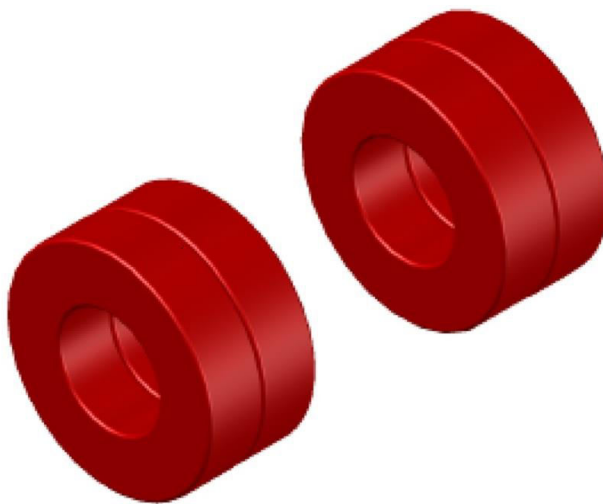

Fig. 3: Arrangement of double bearing in gearbox.

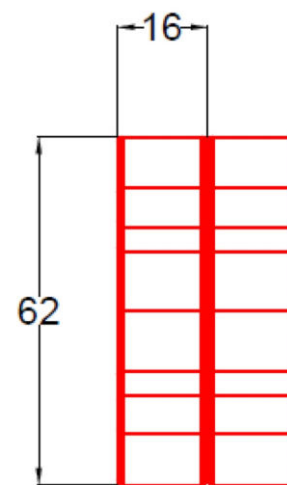

Fig. 4: Combination of two bearing.

**Developed hydro-tiller**

Hydro-tiller is a floating rotary tiller; puddle the low lying fields uniformly with less operation. It is suitable for both primary and secondary tillage when the field has been soaked for at least half a day to soften the soil. The modified hydro-tiller is more suitable for

water-logged, marshy lands. It consists of an engine, gear box, pontoon, cage wheel, clutch lever etc. Its' specification is given in Table 1 and depicted in the Fig. 5.

**Table 1:** Specification of the hydro tiller.

Physical dimensions	Transmission	Engine
Length, 195 cm Width at front, 160 cm Width at rear, 85 cm Height, 75 cm Cage wheel dia, 270 cm	Belt pulley between engine and primary transmission load Enclosed chain and sprocket between primary transmission load to cage wheel	Robin EY 40B Max. power: 8.2 kw Revolution per minute (rpm): 3600

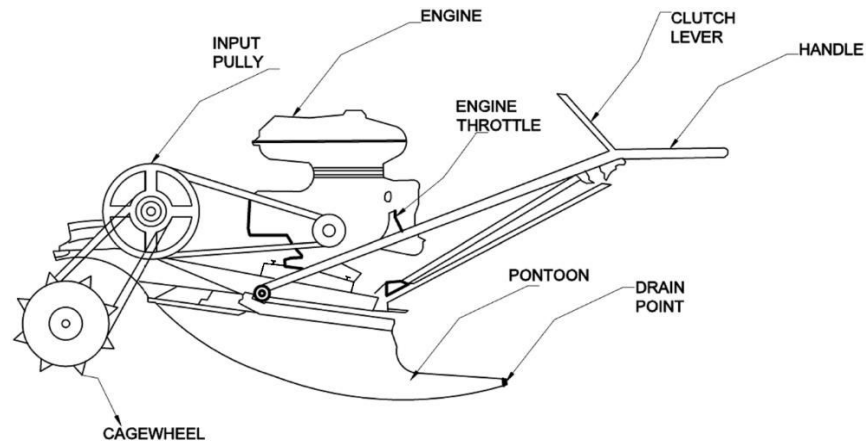

**Fig. 5:** A schematic diagram of the modified Hydro tiller.

**Power transmission system of hydro-tiller**

A 8.2 kw engine was used to increase the capacity of the Hydro-tiller. RPM of the engine is 2800. It was step down to 2400 rpm in the gear box shaft through the power transmission elements i.e. v belt, pulley.

Again, it was step down to 1800 rpm in the cage wheel shaft through the power transmission elements i.e. chain, sprocket, bearing (Fig. 6 & 7). A flow sheet diagram of power transmission system of the modified hydro-tiller is depicted in the Fig. 6.

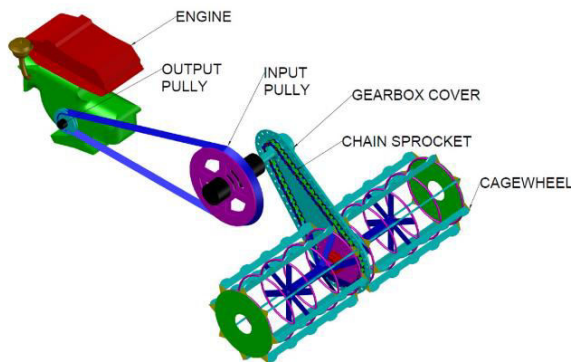

**Fig. 6:** Flow sheet diagram of power transmission system of the modified hydro-tiller.

**Cage wheel**

Cage wheels till and softens the marshy land. Two cage wheels were attached in the gear box shaft. Length of each cage wheel is 478 mm. Diameter of

each cage wheel is 270 mm. An exploded view of power transmission elements of hydro-tiller is presented in the Fig. 8.



**Fig. 7:** Power transmission system of Hydro tiller.

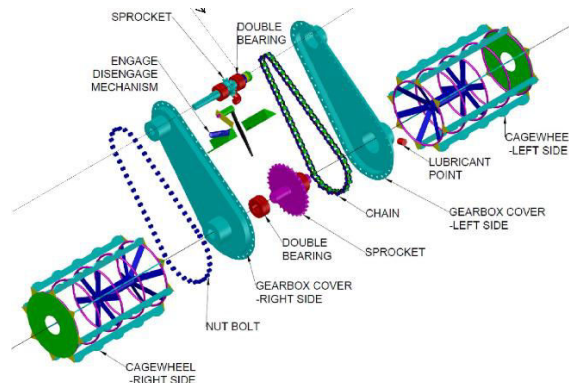

**Fig. 8:** Exploded view of power transmission system between gearbox and cage wheel

**Performance of modified hydro-tiller**

Existing hydro-tiller was tested (Fig. 9) and its capacity was found 0.023 ha/hr. After modification,

the capacity of the hydro-tiller was increased to 0.039 ha/hr. Average fuel consumption of the modified hydro-tiller was 2.01 l/hr (Table 2). Before modifi-



cation of the hydro-tiller, the average number of chain and belt tearing was about 20 and 16 per year, respectively. The number of chain and belt tearing of the hydro-tiller has been decreased to below 8 per year after the modification. On an average 150 number engine stopping event due to overloading was found

every year in the existing hydro-tiller. After modification of the hydro-tiller, this number sharply fall to around 10 last year. No event of engine stopping due to overloading arose during land cultivation this year. This is depicted in the Fig. 10.



Fig. 9: Test of modified hydro-tiller at BRRi west byde, Gazipur.

Table 2: Field performance of the modified hydro-tiller.

Location	No. of trail	Actual rate of area coverage (ha/hr)	Theoretical rate of area coverage (ha/hr)	Field efficiency (%)	Fuel consumption (L/hr)
BRRi West Byde Gazipur	1	0.037	0.061	64.0	1.97
	2	0.039		61.7	2.00
	3	0.041		67.4	2.05

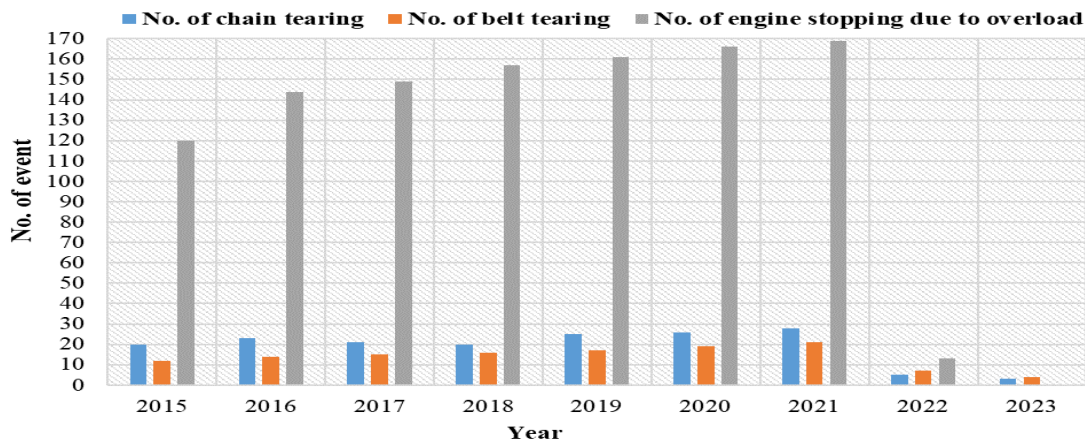

Fig. 10: Chain, belt tearing and engine stopping scenario of the hydro-tiller.

**CONCLUSION:**

The fault of BRRi hydro-tiller chain tearing was identified i.e. thickness of the chain is not sufficient to bear the load, strength of the bearing of the rotary box is not sufficient to bear the load through a field test at BRRi West Byde. The existing BRRi Hydro-tiller was modified accordingly at BRRi research workshop and

tested at BRRi west Byde, Gazipur. Its’ capacity was found 0.039 ha/hr. Its’ capacity increased 0.016 ha/hr. than that of the existing one. The number of chain and belt tearing of the hydro-tiller has been decreased sharply after modification. No engine stopping event due to overloading occurred during land cultivation.

### ACKNOWLEDGEMENT:

This research was performed as part of annual research program of the farm mechanization and postharvest technology program area of Bangladesh Rice Research Institute, Gazipur. Thanks to all of the Workshop Machinery & Maintenance Division, Farm Machinery and Postharvest Technology Division of BRRI for enormous support.

### CONFLICTS OF INTEREST:

The author declares that there is no potential conflict of interest.

### REFERENCES:

- 1) Al-Suhaibani, S. A., Aljnobli, A. A., Al-Majhadi, Y. N., (2006). Tractors and tillage implements performance. Presented at the CSBE/SCGAB 2006 Annual Conference Edmonton Alberta, July 16-19, 2006. P. 06-129.  
<https://doi.org/10.1016/j.jssas.2015.05.003>
- 2) Dash, R. C., Sirohi, N. P. S., (2008). A computer model to select optimum size of farm power and machinery for paddy wheat crop rotation in Northern India. *Agricultural Engineering Inter: The CIGR E journal*, **10**, 1-12.
- 3) Kepner, R. A., Bainer, R., Barger, E. L., (2005). Principles of Farm Machinery. *CBS Publishers & Distributors, Darya Ganj, New Delhi*, **527**.  
<https://handoutset.com/wp-content/uploads/2022-05/Principles-of-Farm>
- 4) Tadeo, B. D., Torrizo, F. M., Gee-Clough, D., (1993). Development and testing of the rear-mounted rotor assembly and float attachments to a Philippine-made power tiller. *Philippine J. of Crop Science*, **18**(2), 107-117.
- 5) Tewari, V. K., Dewangan, K. N., Karmakar, S., (2004). Operator's fatigue in field operation of hand tractors. *Biosystems Engineering*, **89**(1), 1-11.
- 6) Uddin M, Uddin MM, and Khan MAH. (2021). Effect of shift parameters in rational Krylov subspace method for solving Riccati equations arise from power system models, *Int. J. Mat. Math. Sci.*, **3**(2), 43-49.  
<https://doi.org/10.34104/ijmms.021.043049>
- 7) Ujang PAMAN, Shigeki INABA, and Susumu UCHIDA, (2015). Working Performance and Economic Comparison of Three Power Tiller Types for Small-Scale Rice Farming in the Kampar Region of Indonesia. *J. of JSAM*, **77**(5), 363~370.  
[https://www.jstage.jst.go.jp/article/jsamfe/77/5/77\\_363/pdf](https://www.jstage.jst.go.jp/article/jsamfe/77/5/77_363/pdf)
- 8) Villaruz, M. S. (1985). The floating power tiller in the Philippines. In: Small Farm Equipment for Developing Countries: Proceedings of the International Conference on Small Farm Equipment for Developing Countries: Past Experience and Future Priority, 2-6 September 1985. Manila, Philippines, 173-178.
- 9) Wanjun, W. J. (2015). Profile of the development of agricultural mechanization in China. *Agricultural Mechanization in Asia, Africa, and Latin America*, **14**(1), 41-43.  
<https://agriknowledge.affrc.go.jp/RN/2010923254.pdf>

**Citation:** Hossain MA, Bhuiyan MGK, Rahaman H, Ahmmed MM, Huda MD, and Khan AU. (2023). Modification of power transmission system of BRRI hydro-tiller, *Int. J. Mat. Math. Sci.*, **5**(3), 19-24.  
<https://doi.org/10.34104/ijmms.023.019024> 